



**Tissue & Napkin
Dispenser
Dryer
Tissue Holder
Aroma Diffuser**

Sanitary Ware & Hygienic Solutions

SVAVO
By **Cleanatic**





● **MANUAL SOAP DISPENSER**

Keep clean at all times



Visibility of usage



350ml capacity



Wall mounted



Plastic material

Sanitizing Products

www.cleanatic.com



Wall-mounted



Liquid outlet



350ml capacity

SVAVO
By **Cleanatic**

Product Specification

Unit size	L88*W85*H165mm
Vol	350ml
Material	ABS
Unit weight	207.2g
Installation	Wall-mounted



White



Tel: 087-777-7272
info@cleanatic.com



Liquid Type

● MANUAL SOAP DISPENSER

Keep clean at all times



Visibility of usage



Liquid soap



Punch free installation



Plastic material

Sanitizing Products

www.cleanatic.com



Invisible opening design



Liquid outlet



600ml Capacity

SVAVO

By **Cleanatic**

Product Specification

Unit size	L113*W130*H217mm
Vol	600ml
Unit weight	400g
Material	ABS
Liquid amount	0.8-1ml
Installation method	Wall-mounted



White



Tel: 087-777-7272
info@cleanatic.com



Foam Type

● MANUAL SOAP DISPENSER

Keep clean at all times



Visibility of usage



Foam



Punch free installation



Plastic material

Sanitizing Products

www.cleanatic.com



Invisible opening design



Liquid outlet



600ml Capacity

SVAVO
By **Cleanatic**

Product Specification

Unit size	L113*W130*H217mm
Vol	600ml
Unit weight	400g
Material	ABS
Liquid amount	0.8-1ml
Installation method	Wall-mounted



White-grey



Tel: 087-777-7272
info@cleanatic.com



www.cleanatic.com

Cleanatic



SPRAY DISPENSER (600 ML)

Sanitizing Products



SVAVO
By Cleanatic

Product Specification

Model	:	▪ SV-VX688
Volume	:	▪ up to 600 ml
Product size	:	▪ L113×W130×H217 mm
Weight	:	▪ 400g
Material	:	▪ ABS
Color	:	▪ White



White



Tel: 087-777-7272
info@cleanatic.com

Sanitizing Products

www.cleanatic.com

Liquid Type

• MANUAL SOAP DISPENSER

Keep clean at all times



Visibility of usage



Security lock



Punch free installation



Plastic material

Cleanatic



Visibility of usage



Security lock



800ml Capacity

SVAVO
By Cleanatic

Product Specification

Unit size	L119*W106*H245mm
Vol	800ml
Unit weight	400g
Material	ABS
Hole distance	62*85mm
Liquid amount	0.8-1ml
Installation method	Wall-mounted



White



Tel: 087-777-7272
info@cleanatic.com

Sanitizing Products

www.cleanatic.com



Liquid Type

● MANUAL DOUBLE SOAP DISPENSER

It can be filled with shampoo and body wash



Double soap dispenser



Security lock



Punch free installation



Plastic material

Cleanatic



Two liquids



Security lock



500ml*2 Capacity

SVAVO
By **Cleanatic**

Product Specification

Unit size	L145*W95*H251mm
Vol	500ml*2
Unit weight	582.5g
Material	ABS
Hole distance	62*85mm
Liquid amount	0.8-1ml
Installation method	Wall-mounted



White



Tel: 02-168-3154, 087-777-7272
info@cleanatic.com

Sanitizing Products

www.cleanatic.com



Liquid Type
● **INFRARED SENSOR**
Intelligent and hand free



Large capacity



Liquid amount adjustable



Infrared sensor



Safety lock

Cleanatic



4pcs C batteries



Sensor work area



1000ml Large capacity

SVAVO
By **Cleanatic**

Product Specification

Unit size	L285*160*120mm
Vol	1000ml
Unit weight	1100g
Material	ABS



White



Tel: 087-777-7272
info@cleanatic.com



Foam Type

- **INFRARED SENSOR**
Intelligent and hand free

1000ml capacity

Liquid amount adjustable



Sanitizing Products

www.cleanatic.com

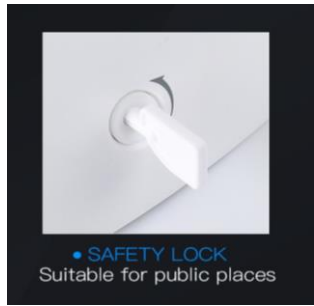
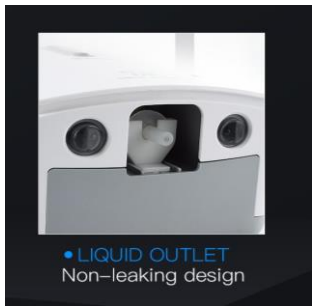

A: 4pcs "C" size alkaline batteries(not included)

💡 (Low battery indication, red LED blinks every 3 seconds to remind battery changing)

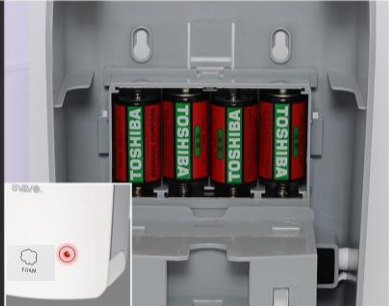

SVAVO
By **Cleanatic**

Product Specification

Unit size	L285*160*120mm
Vol	1000ml
Unit weight	1100g
Material	ABS



White-grey



Tel: 087-777-7272
info@cleanatic.com



Don't let your hands become the residence of germs.

The sterilizer can quickly and effectively remove germs on hands prevent the spread and reproduction of germs.



Infrared reflection type



No contact



Cleanatic



A:4pcs AA size alkaline batteries(not included)

☀️ (Low battery indication,red LED blinks every 3 seconds to remind battery changing)



Sanitizing Products

www.cleanatic.com

Delicate appearance
Contracted fashion



SVAVO

By **Cleanatic**

Product Specification

Volume	:	▪ Up to 600 ml
Product size	:	▪ L137×W109×H418mm
Weight	:	▪ 713.2g
Material	:	▪ ABS



White



Tel: 087-777-7272
info@cleanatic.com



Liquid Type

● AUTOMATIC SOAP DISPENSER

Intelligent and hand free



700ml capacity



Power switch



Hand free



Health and environmental protection

Sanitizing Products

www.cleanatic.com



4pcs AA batteries

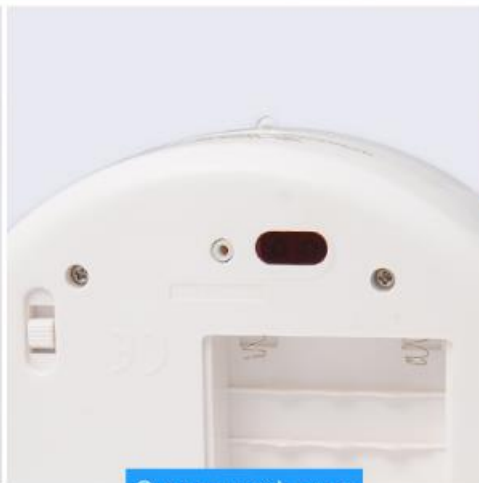

Sensor work area

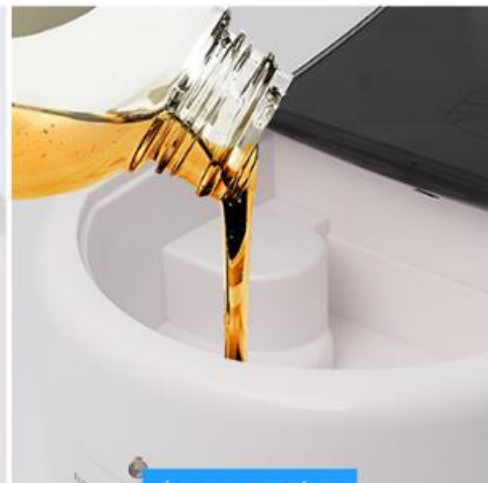

Large opening

SVAVO

By Cleanatic

Product Specification

Unit size	L185*W140*H165mm
Vol	700ml
Material	ABS
Installation	Wall-mounted/Tabletop



Tel: 087-777-7272
info@cleanatic.com

Sanitizing Products

www.cleanatic.com



Liquid Type

● INFRARED SENSOR

Intelligent and hand free



Liquid amount adjustable



500ml Capacity



Hand free



Health and environmental protection

Cleanatic



4*1.5V AA batteries



Sensor work area



500ml Capacity

SVAVO
By **Cleanatic**

Product Specification

Unit size	L55*W85*H220mm
Vol	500ml
Unit weight	420g
Material	ABS

Technic Parameter

Working voltage	DC6V
Working current	400mA
Induction distance	60uA
Standby current	0-8cm



White



Tel: 087-777-7272
info@cleanatic.com

Sanitizing Products

www.cleanatic.com

•AUTOMATIC PERFUME DISPENSER

Timing to eliminating off-flavor



Work mode



LCD Screen



Hand free



Interval spray

Cleanatic



2pcs D size batteries

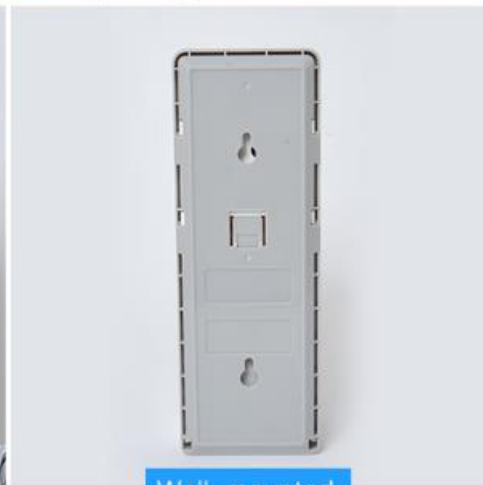

Wall-mounted



L6.5*H14cm

SVAVO
By Cleanatic

Unit Specification

Unit weight	480g
Unit size	L86*W83*H238mm
Material	ABS
Work mode	Day/Night/24h
Working voltage	DC3V
Working current	500mA
Interval spray	5/15/25minutes



Tel: 087-777-7272
info@cleanatic.com

● HAND DRYER

10 seconds dry hand



Intelligent temperature control



HEPA strainer sterile wind



Human body charge induction



Safety protection



Bottom display



Electric Safety Power Switch



1450W high power

Sanitizing Products

www.cleanatic.com

Unit Specification

Unit size	L232*W131*H327mm
Unit weight	3kg
Material	ABS+PC
Induction distance	3-5cm



Tel: 02-168-3154, 087-777-7272

info@cleanatic.com

● **HAND DRYER**

Dry your hands quickly



High speed motor



Intelligent temperature control



Human body charge induction



Safety protection

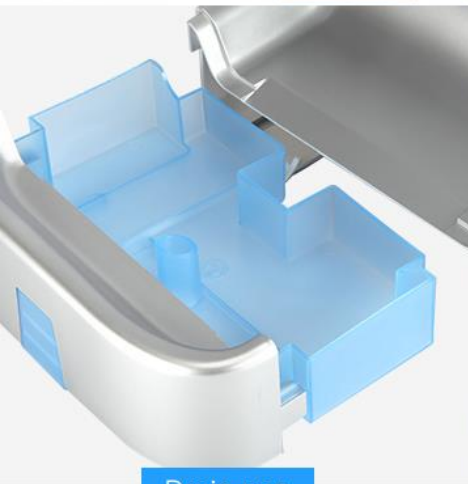

Drain pan



Air outlet



1350W high power

Sanitizing Products

www.cleanatic.com

Unit Specification

Unit size	L250*W168*H242mm
Unit weight	3800g
Rated Power	1350W
Working Voltage	AC220-240V~50Hz-60Hz
Air speed	30m/sec



White



Tel: 02-168-3154, 087-777-7272

info@cleanatic.com